

bancor

**Compact, Fast & Powerful solution for
Checks and Document Processing**

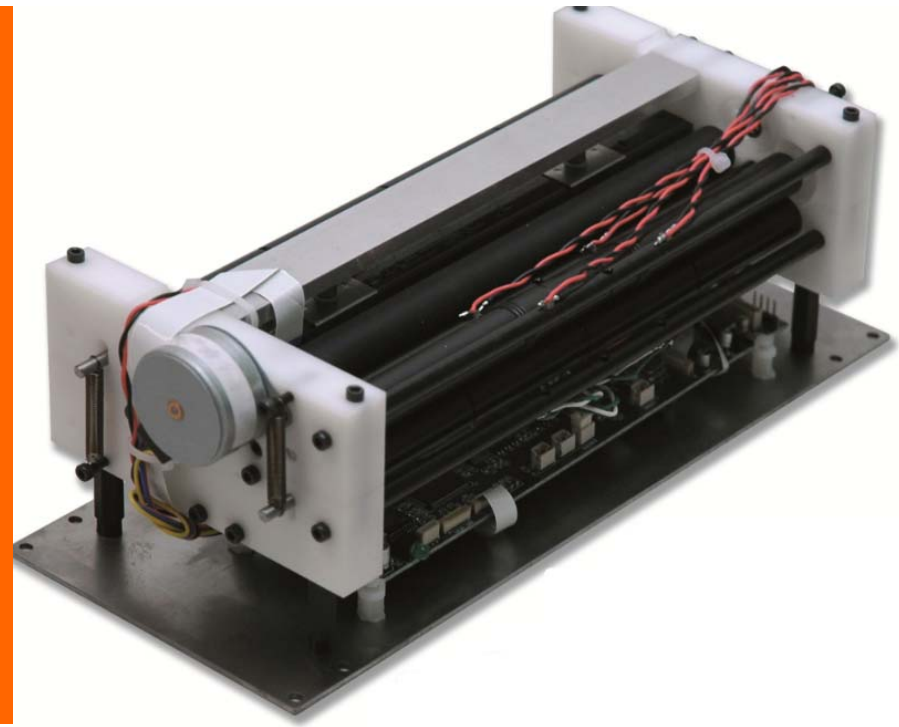

Lector BSC

Milano – Italy



Compact, Fast & Powerful solution for Checks and Document Processing

Lector BSC – A4 MODEL

bancor LECTOR BSC is a “Revolutionary“ kiosk scanner and reader

LECTOR ATM is a new high performance reader device for electronic management of bank and other documents directly at your kiosk

- **Simultaneously on both sides**
- Up to **Letter / A4 format** (8½ by 11 inches)
- also **rigid document** up to card dimension (3.3 × 2.1 inches)

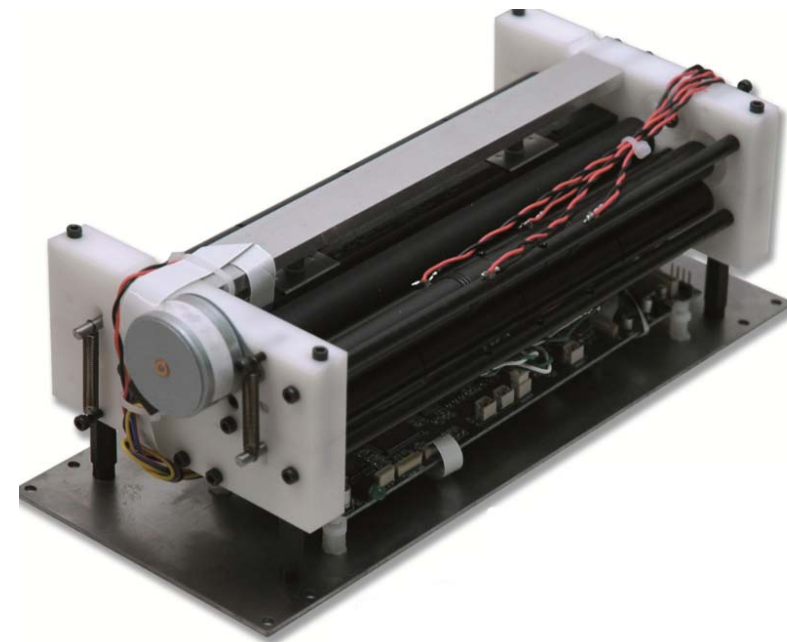

bancor



Compact, Fast & Powerful solution for Checks and Document Processing

Lector BSC – A4 MODEL

WITH LECTOR K2S YOU CAN SCAN & PROCESS:

- Any bank document
- Cheques
- Invoices
- Coupons
- Proxies
- Bank deposit slips
- Post Office deposit slips
- Documents
- Identity cards
- Driving License
- Any Plastic card
- ID badge
- And any other document.....

in-store savings coupon
NOW THRU THURSDAY, JANUARY 31ST

Item	Type	Bank Number
1	Check	16-24
2	Check	56-1263
3	Check	96-401
4	Check	79-379
5	Check	55-230
6	Check	79-1207
7	Check	90-4110
8	Check	11-4288
9	Check	50-1149
10	Check	56-85
11	Check	87-190
12	Check	90-4110
13	Check	90-3298
14	Check	56-29
15	Check	16-66
16	Check	16-1606
17	Check	64-175
18	Check	90-3752
19	Check	12-73

Item	Type	Bank Number
1	Credit Card	CREDIT CARD
2	Credit Card	CREDIT CARD
3	Credit Card	CREDIT CARD
4	Credit Card	CREDIT CARD
5	Credit Card	CREDIT CARD
6	Credit Card	CREDIT CARD

NEW YORK STATE DRIVER LICENSE CLASS D

Jolly Technologies
DOB: 07/28/75
Height: 5'5"
Weight: 115
Hair: Brown
Eyes: Brown
Maria Bordeau
123-45 6789
Maria Bordeau Staff

bancor



Compact, Fast & Powerful solution for Checks and Document Processing

Lector BSC – DECODING ICR / OCR / BAR CODE

Digitalize and decode any document

DIANA KEATING
 dianak@aol.com
 54 West Maplewood Drive
 Granbury, TX 611 46 (274) 486-8392 (H)
 (274) 537-9713 (V)

February 1, 20XX

Mr. Allen Wood
 Human Resources Manager
 Attractive Marketing
 Suite 12, 1432 West Madison Avenue
 Appletton, WV 62549

Dear Mr. Wood:

It is with your organization that I desire to offer nearly 15 years of marketing management expertise and resourceful insight in strategic marketing methodologies. Having a strong background utilizing a variety of direct response advertising materials, I am certain that my skills and experience, when linked with the vision of your company, will serve to create dramatic, profitable results.

As Marketing Director for ABC Associations, I am consistently energized by opportunities in overcoming promotional boundaries as I continue to ensure that our lines receive the best representation in achieving new customer acquisition and creating brand awareness through direct marketing efforts. With full accountability for over a multi-million-dollar budget, I currently offer significant contributions in revenue growth through visible skills in the tactical planning of pricing, packaging, and distribution, as well as, offer strategies and mail planning.

Having natural interpersonal and communication abilities, I have acquired a solid reputation for effective networking and strategic alliance building among crucial industry resources. In providing a solution driven leadership style during the acquisition of ABC Group, I was able to build and mobilize highly effective marketing programs that encouraged profit achievements for this groups largest financial continuity program. Under my guidance we:

- Grew revenue per customer, 10% and retained 5% more customers by motivating managers to reflect the needs of the target market.
- Expanded new enrollments 35% by investigating, developing, and testing new creative initiatives and list segmentation, expansion, and refinements.
- Increased ABC Association's response rate and back-end performance 15% while containing expenditures.

As there is considerably more to relate, I look forward to our meeting and discussion regarding how I might assist the marketing needs and further advance the visibility of your company.

Sincerely,

Diana Keating



Enclosure

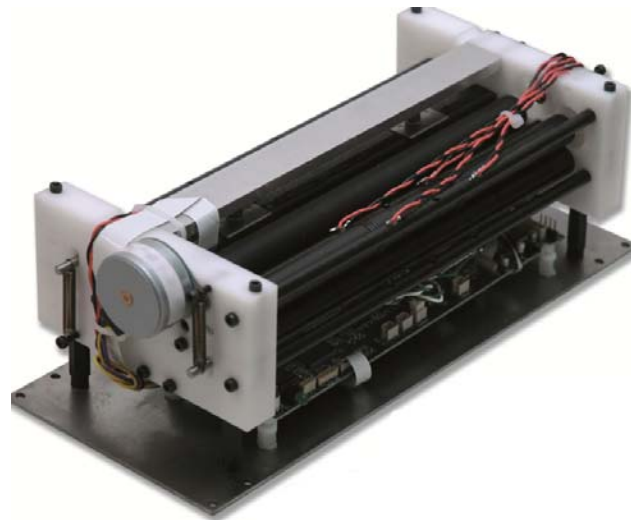
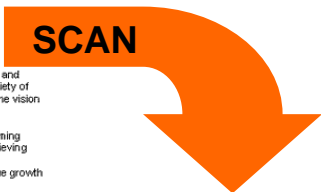



Compact, Fast & Powerful solution for Checks and Document Processing

Lector BSC – TECHNICAL SPECIFICATION (1/2)

- **IMAGE QUALITY**

- 256 shade grayscale up to 600 dpi
- 24bit color up to 300 dpi
- Compression format: TIFF, JPG, BMP
- **AUTOCROP: Margins are automatically removed from images**
- **AUTODESKEW**

- **HW INTERFACE**

- USB 2.0 (1.1 compatible)

- **SW INTERFACE**

- TWAIN, API

- **OPERATING SYSTEM**

- Microsoft Certified Driver for: Windows® 98SE, Windows® ME, Windows® XP, Vista Windows®, Windows® 2000, Windows® 2003 server and “Windows® 7”; all systems in 32 & 64 bit.



Compact, Fast & Powerful solution for Checks and Document Processing

Lector BSC – TECHNICAL SPECIFICATION (2/2)

- **Options**
 - 96 dpi inkjet
- Lector ATM is also available in A6 format with the same specification as Lector ATM A4

Lector ATM A6

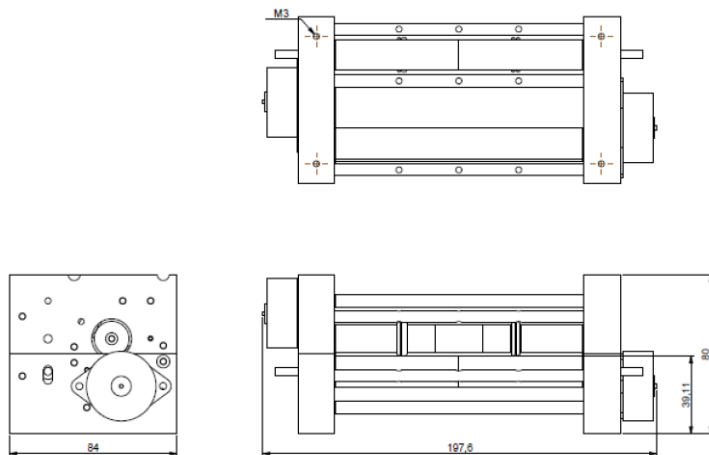

Lector ATM A4

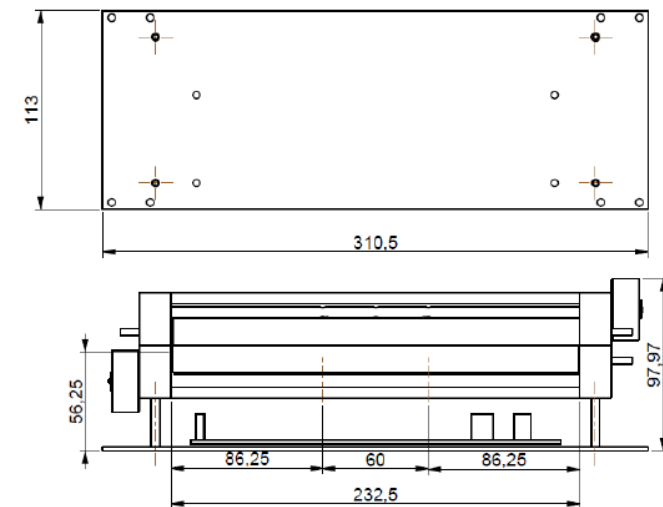





Compact, Fast & Powerful solution for Checks and Document Processing

Lector BSC – FONTS

ON-BOARD SOFTWARE DECODING:

- E13B 1234567890 11 12 13 14
- CMC7  12345
- OCRB 34567890 (\$ £ € . , ! ?)
- OCRA 1234567890 <A B C D E F G H >
- BAR CODES linear 
- BAR CODES bidimensional (PDF417) 
- API for ICAO Passport and identity card recognition



Compact, Fast & Powerful solution for Checks and Document Processing

Lector BSC– WARRANTY & PROTECTION PROGRAM

***bancor* offers a 1 YEAR WARRANTY
for all installed LECTOR K2s**

**Warranty can be enhanced with an extended maintenance program,
which guarantees to customers the repair of their LECTOR K2s**

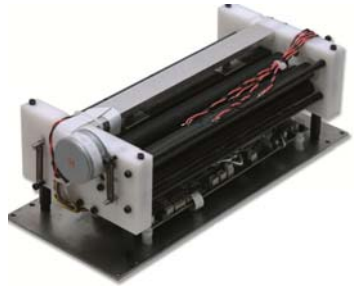

Compact, Fast & Powerful solution for Checks and Document Processing

Some of Our Client

INTESA  SANPAOLO



bancor

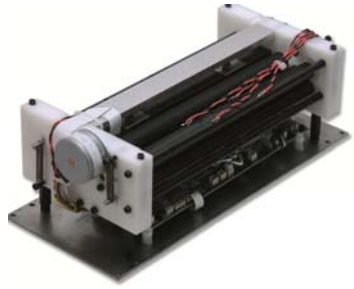

Compact, Fast & Powerful solution for Checks and Document Processing

bancor – contact information

Web: www.bancor.it

Mail: info@bancor.it

Phone: 0039 02 2664215

Fax: 0039 02 2362992

Mobile : 0039 3939764915

Address: Via Luigi Vanvitelli 44

Zip Code: 20129

City: Milano

State: Italy

bancor